

White side up

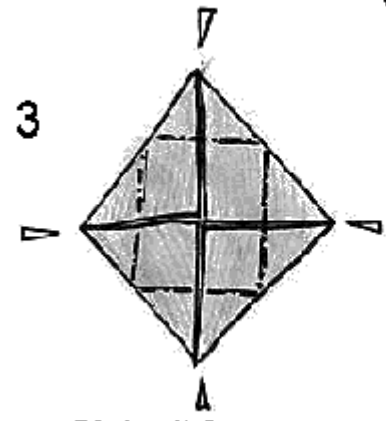

Sink all four corners to centre of model

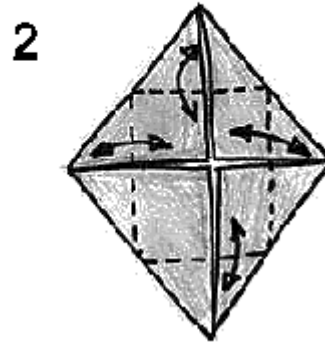
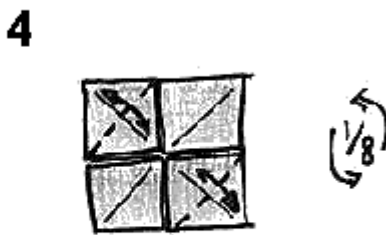

Fold and unfold

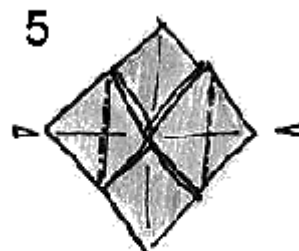

Sink. Make sure a coloured layer lie on top

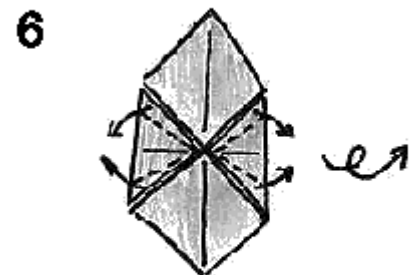

Form legs. Turn over

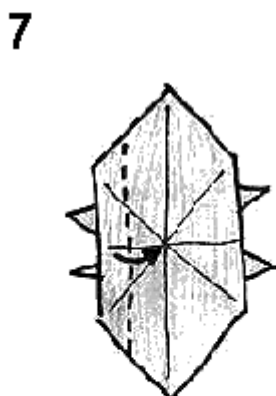

Fold to centre. Include feet but not bottom layer

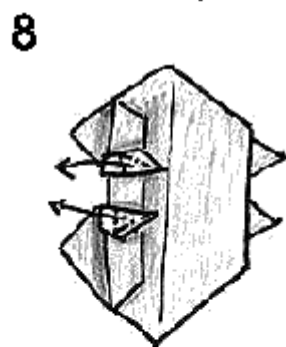

Rabbit ear fold to form legs

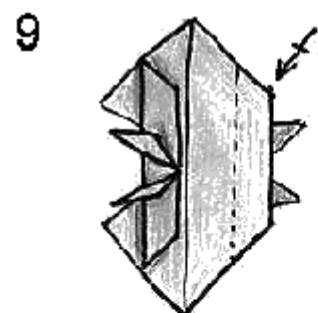

Repeat steps 7-8 on other side

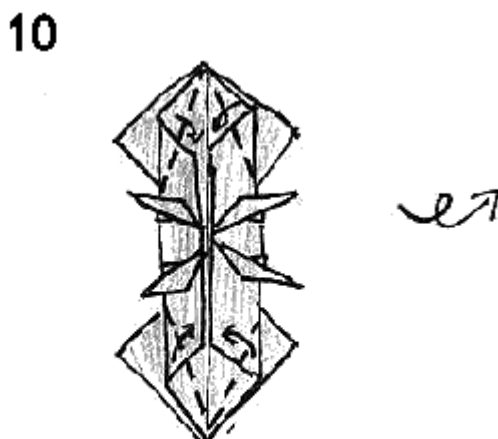

Fold to centre and turn over

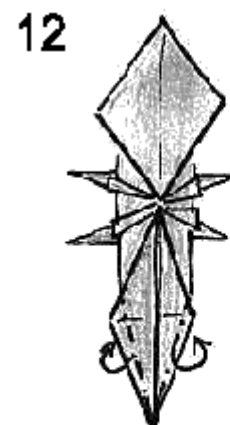
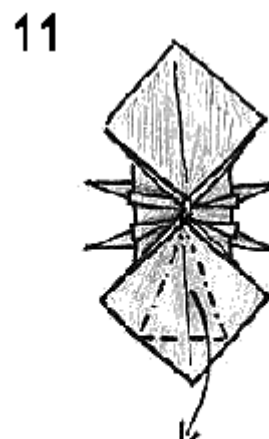

Fold under to shape tail

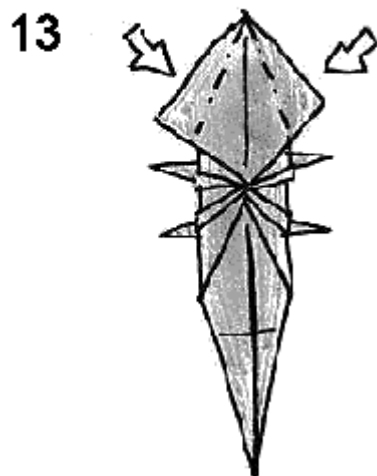

Reverse folds  
to form head

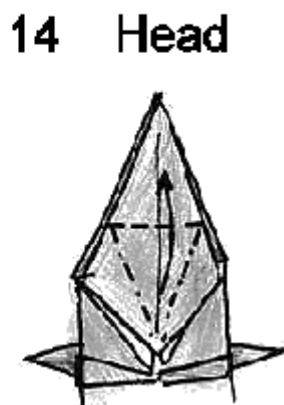

Petal fold  
upwards

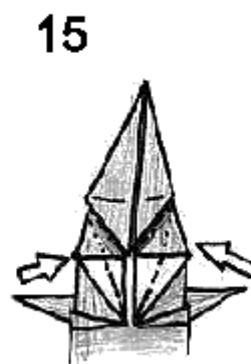

Reverse fold

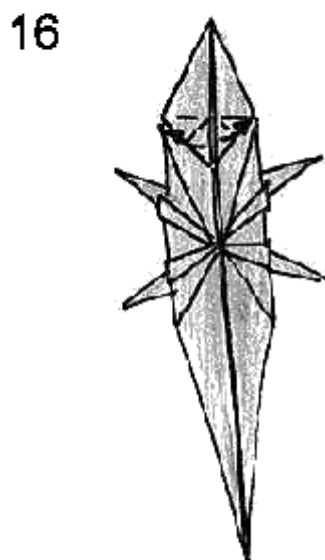

Fold eyes. The feet  
can be adjusted if  
required

Finished George  
the Crocodile

